

ERGO WORK

BRACCI ESTENSIBILI SERIE PRO

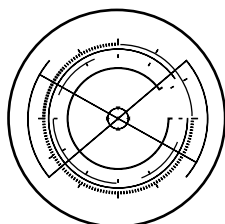

I **bracci estensibili** Ergo Work aumentano lo spazio di stoccaggio a disposizione dell'operatore su banchi da lavoro e carrelli. È possibile scegliere tra due diverse tipologie di bracci: i primi possono essere installati direttamente sul **montante** della parete attrezzata, mentre i secondi sono fissati sul **piano di lavoro**. Grazie all'ampio angolo di rotazione, la posizione del braccio può essere facilmente regolata così da avere tutto a portata di mano e rendere la postazione sempre più ergonomica. Ergo Work può ospitare vassoi, piastre porta monitor, soluzioni con contenitori e pannelli forati.



CONFIGURABILE

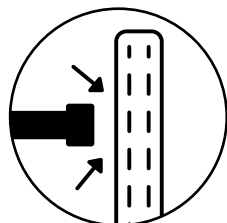

FISSAGGIO SU
MONTANTE

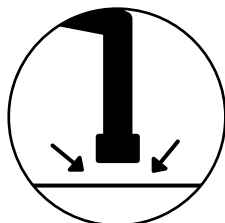

FISSAGGIO SU
PIANO



PORTATA 20 KG

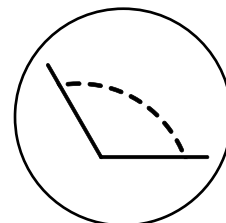

ANGOLO
ROTAZIONE 240-
260°

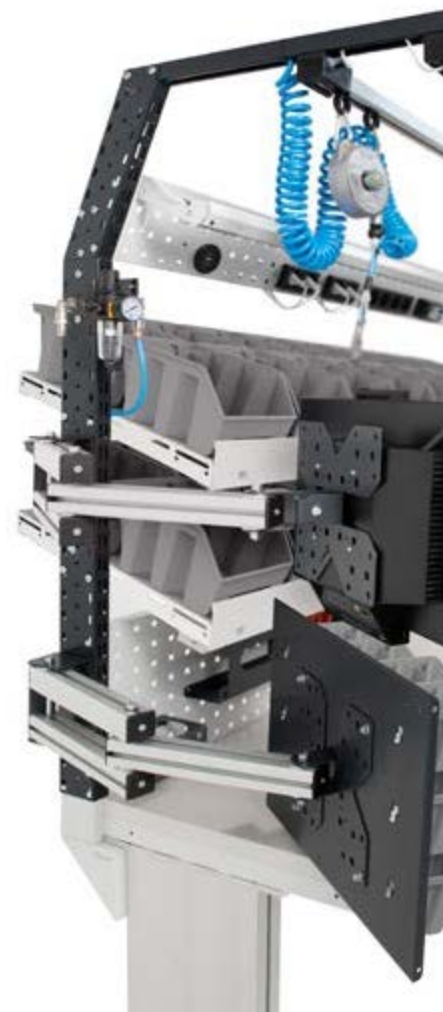

CONFIGURE

SHOP

PATENTED*

| ART. | L mm | P mm | H mm | KG | RAL | € |
|-------------|-----------|------|-----------|-----|-----------|---------|
| DYNAMIC1506 | 1497/3139 | 780 | 1983/2383 | 400 | 7035+7016 | 4530,90 |

Composto da:

| qtà | descrizione | qtà | descrizione |
|-----|---|-----|---|
| 1 | Banco smontato regolabile elettricamente | 1 | Multipresa schuko a 4 scomparti |
| 1 | Armadio L=500 mm con 1 cassetto H=150 mm | 2 | Multipresa schuko a 2 scomparti |
| 1 | Coperchio per armadio L=500 mm | 1 | Presse usb ricarica |
| 1 | Coppia supporti per armadio | 1 | Presse usb dati |
| 1 | Telaio portaprese aggiuntivo completo di tamponi e angolari | 1 | Cavo di collegamento wieland schuko/francese |
| 1 | Kit 2 montanti biasolati | 1 | Dispenser per guanti |
| 1 | Kit 2 supporti inclinati con binario | 1 | Porta flacone igienizzante reversibile |
| 1 | Lampada doppia | 36 | Contenitore in polipropilene Picking Box Air mis. 2 |
| 1 | Binario supplementare con attacchi | 4 | Braccio estensibile per montante |
| 1 | Set aria compressa con bilanciatore e filtro | 1 | Snodo per piastra |
| 2 | Pannello forato/mensola con 1 bordo fermacasse | 3 | Piastra porta monitor con standard VESA |
| 3 | Lampada singola | 1 | Pannello per Picking Box |
| 1 | Pannello forato/mensola | 3 | Barra aggancio per contenitori Picking Box mis. 1/2 |
| 1 | Pannello forato Electric | 3 | Kit 4 contenitori Picking Box Air mis. 1 |
| 2 | Gancio Unipok per utensili - confezione 30 pezzi | 1 | Pannello per Visual Box |
| 1 | Magnetotermico differenziale | 2 | Cassettera Visual Box con 6 cassette |
| 1 | Vassoio inclinato | 1 | Cassettera Visual Box con 5 cassette |



PORTATA



RAL 7035 + RAL 7016



BRACCIO ESTENSIBILE CON PICKING BOX

| ART. | L mm | P mm | H mm | RAL | € |
|---|---------|---------|------|------|--------|
|  ERGOWORK002 | 760/515 | 470/283 | 356 | 7016 | 185,10 |

Composto da:

| qtà | descrizione |
|-----|---|
| 1 | Braccio estensibile per montante |
| 1 | Piastra porta monitor con standard VESA |
| 1 | Pannello per Picking Box |
| 3 | Barra aggancio per contenitori Picking Box mis. 1/2 |
| 3 | Kit 4 contenitori Picking Box Air mis. 1 |



BRACCIO ESTENSIBILE CON PICKING BOX

| ART. | L mm | P mm | H mm | RAL | € |
|---|---------|---------|------|------|--------|
|  ERGOWORK003 | 826/515 | 470/348 | 356 | 7016 | 177,60 |

Composto da:

| qtà | descrizione |
|-----|---|
| 1 | Braccio estensibile per montante |
| 1 | Piastra porta monitor con standard VESA |
| 1 | Pannello per Picking Box |
| 2 | Barra aggancio per contenitori Picking Box mis. 1/2 |
| 1 | Kit 3 contenitori Picking Box Air mis. 2 |
| 1 | Kit 4 contenitori Picking Box Air mis. 1 |



BRACCIO ESTENSIBILE CON VISUAL BOX

| ART. | L mm | P mm | H mm | RAL | € |
|---|---------|---------|------|------|--------|
|  ERGOWORK004 | 738/612 | 601/294 | 390 | 7016 | 222,90 |

Composto da:

| qtà | descrizione |
|-----|---|
| 1 | Braccio estensibile per montante |
| 1 | Piastra porta monitor con standard VESA |
| 1 | Pannello per Visual Box |
| 1 | Cassettiera Visual Box con 5 cassette |
| 2 | Cassettiera Visual Box con 6 cassette |



PIASTRA PORTA MONITOR CON SQUADRETTE

| ART. | L mm | P mm | H mm | RAL | € |
|---|---------|---------|------|------|-------|
|  ERGOWORK014 | 225/129 | 119/225 | 225 | 7016 | 42,00 |

Composto da:

| qtà | descrizione |
|-----|---|
| 1 | Coppia squadrette a L |
| 1 | Snodo per piastra |
| 1 | Piastra porta monitor con standard VESA |



PANNELLO FORATO CON CERNIERE

| ART. | L mm | P mm | H mm | RAL | € |
|---|------|------|------|------|-------|
|  ERGOWORK007 | 647 | 60 | 496 | 7035 | 68,70 |

Composto da:

| qtà | descrizione |
|-----|--|
| 1 | Pannello forato/mensola con 1 bordo fermacasse |
| 1 | Kit cerniere per pannello forato |



BRACCIO ESTENSIBILE CON VASSOIO INCLINATO

| ART. | L mm | P mm | H mm | RAL | € |
|---|---------|---------|------|------|--------|
|  ERGOWORK005 | 674/522 | 425/470 | 194 | 7016 | 146,40 |

Composto da:

| qtà | descrizione |
|-----|----------------------------------|
| 1 | Braccio estensibile per montante |
| 1 | Vassoio inclinato |



BRACCIO ESTENSIBILE CON PIASTRA PORTA MONITOR

| ART. | L mm | P mm | H mm | RAL | € |
|---|---------|---------|------|------|--------|
|  ERGOWORK001 | 652/330 | 225/225 | 225 | 7016 | 129,30 |

Composto da:

| qtà | descrizione |
|-----|---|
| 1 | Braccio estensibile per montante |
| 1 | Snodo per piastra |
| 1 | Piastra porta monitor con standard VESA |



 RAL 7016

 RAL 7035



CONFIGURE 

SHOP 

| ART. | L mm | P mm | H mm |  senza ruote |  set ruote | RAL | € |
|------------|------|------|------|---|---|------|--------|
| CLEVER1031 | 1036 | 672 | 1428 | 300 | 300 | 7035 | 646,50 |

Composto da:

| qtà | descrizione |
|-----|-------------------------------|
| 1 | Carrello smontato senza ruote |
| 1 | Piano in legno con supporti |
| 2 | Pannello laterale forato |
| 1 | Pannello posteriore forato |
| 1 | Coppia porte a battente |

| qtà | descrizione |
|-----|---|
| 1 | Profilo con base per piano |
| 1 | Coppia squadrette a L |
| 1 | Snodo per piastra |
| 1 | Piastra porta monitor con standard VESA |
| 1 | Kit ruote in gomma antitraccia sintetica Ø 125 mm |



BRACCIO ESTENSIBILE CON VASSOIO INCLINATO



| ART. | L mm | P mm | H mm | RAL | € |
|-------------|---------|---------|------|------|--------|
| ERGOWORK013 | 745/521 | 425/480 | 552 | 7016 | 189,60 |

Composto da:

| qtà | descrizione |
|-----|---------------------------------|
| 1 | Profilo con base per piano |
| 1 | Braccio estensibile per profilo |
| 1 | Vassoio inclinato |

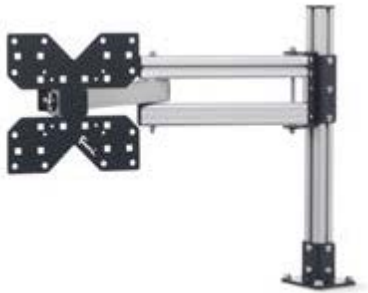

BRACCIO ESTENSIBILE CON PIASTRA PORTA MONITOR



| ART. | L mm | P mm | H mm | RAL | € |
|-------------|---------|---------|------|------|--------|
| ERGOWORK009 | 724/402 | 225/192 | 550 | 7016 | 172,50 |

Composto da:

| qtà | descrizione |
|-----|---|
| 1 | Profilo con base per piano |
| 1 | Braccio estensibile per profilo |
| 1 | Snodo per piastra |
| 1 | Piastra porta monitor con standard VESA |



PROFILO CON PIASTRA PORTA MONITOR



| ART. | L mm | P mm | H mm | RAL | € |
|-------------|---------|---------|------|------|-------|
| ERGOWORK008 | 225/199 | 151/225 | 560 | 7016 | 82,20 |

Composto da:

| qtà | descrizione |
|-----|---|
| 1 | Profilo con base per piano |
| 1 | Coppia squadrette a L |
| 1 | Snodo per piastra |
| 1 | Piastra porta monitor con standard VESA |



PORTATA



RAL 7016



RAL 7035



BRACCIO ESTENSIBILE CON PICKING BOX

| ART. | L mm | P mm | H mm | RAL | € |
|---|---------|---------|------|------|--------|
|  ERGOWORK010 | 832/515 | 470/300 | 628 | 7016 | 228,30 |

Composto da:

| qtà | descrizione |
|-----|---|
| 1 | Profilo con base per piano |
| 1 | Braccio estensibile per profilo |
| 1 | Piastra porta monitor con standard VESA |
| 1 | Pannello per Picking Box |
| 3 | Barra aggancio per contenitori Picking Box mis. 1/2 |
| 3 | Kit 4 contenitori Picking Box Air mis. 1 |



BRACCIO ESTENSIBILE CON PICKING BOX

| ART. | L mm | P mm | H mm | RAL | € |
|--|---------|---------|------|------|--------|
|  ERGOWORK011 | 898/515 | 470/365 | 628 | 7016 | 220,80 |

Composto da:

| qtà | descrizione |
|-----|---|
| 1 | Profilo con base per piano |
| 1 | Braccio estensibile per profilo |
| 1 | Piastra porta monitor con standard VESA |
| 1 | Pannello per Picking Box |
| 2 | Barra aggancio per contenitori Picking Box mis. 1/2 |
| 1 | Kit 3 contenitori Picking Box Air mis. 2 |
| 1 | Kit 4 contenitori Picking Box Air mis. 1 |



BRACCIO ESTENSIBILE CON VISUAL BOX

| ART. | L mm | P mm | H mm | RAL | € |
|---|---------|---------|------|------|--------|
|  ERGOWORK012 | 808/601 | 601/275 | 668 | 7016 | 266,10 |

Composto da:

| qtà | descrizione |
|-----|---|
| 1 | Profilo con base per piano |
| 1 | Braccio estensibile per profilo |
| 1 | Piastra porta monitor con standard VESA |
| 1 | Pannello per Visual Box |
| 1 | Cassettera Visual Box con 5 cassette |
| 2 | Cassettera Visual Box con 6 cassette |



| ART. | L mm | P mm | H mm | KG | RAL | € |
|--------------|------|------|-----------|------|-----------|---------|
| MASTERBR2008 | 3347 | 750 | 1985/2360 | 1000 | 7035+7016 | 2791,80 |

Composto da:

| qtà | descrizione |
|-----|---|
| 1 | Banco smontato con piano in multiplex 40 mm |
| 1 | Copertura per piano in multiplex |
| 1 | Armadio L=560 mm con 4 cassetti 1x75 2x150 1x200 |
| 1 | Armadio L=560 mm predisposto per porta con 1 piano regolabile |
| 1 | Porta totale sinistra H=600 mm con maniglia Dark Grey |
| 2 | Semipiano aggiuntivo L=560 mm |
| 1 | Kit 2 montanti biasolati |
| 1 | Kit 2 supporti inclinati con binario |
| 1 | Binario supplementare con attacchi |
| 1 | Lampada doppia |
| 1 | Kit 3 pannelli forati/mensole con 2 bordi fermacasse |
| 1 | Pannello forato Electric |
| 2 | Multipresa schuko a 2 scomparti |
| 1 | Multipresa schuko a 4 scomparti |
| 1 | Piastra porta monitor con standard VESA |

| qtà | descrizione |
|-----|---|
| 1 | Magnetotermico differenziale |
| 1 | Cavo di collegamento wieland schuko/francese |
| 1 | Porta flacone igienizzante reversibile |
| 1 | Dispenser per guanti |
| 1 | Kit porta rotolo con carta Ø=240 mm |
| 4 | Kit 2 contenitori Picking Box Air mis. 3A2 |
| 2 | Pannello forato/mensola con 1 bordo fermacasse |
| 2 | Kit cerniere per pannello forato |
| 8 | Barra aggancio per contenitori Picking Box mis. 1/2 |
| 4 | Kit 4 contenitori Picking Box Air mis. 1 |
| 4 | Kit 3 contenitori Picking Box Air mis. 2 |
| 2 | Profilo con base per piano |
| 2 | Braccio estensibile per profilo |
| 1 | Vassoio inclinato |
| 1 | Snodo per piastra |



PORTATA



RAL 7035 + RAL 7016



RAL 7016

COMPONENTI

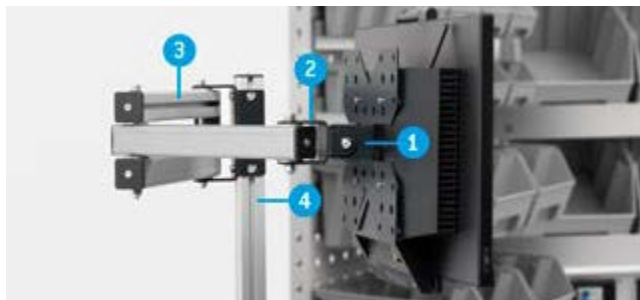

1. Piastra porta monitor con standard VESA
2. Snodo per piastra
3. Braccio estensibile per profilo
4. Profilo con base per piano

1. Piastra porta monitor con standard VESA
2. Pannello per Visual Box
3. Cassettiera Visual Box con 6 cassetti
4. Braccio estensibile per montante



BRACCIO ESTENSIBILE PER MONTANTE

| ART. | L mm | P mm | H mm | angolo rotazione ° | materiale | KG | RAL | € |
|--|---------|-------|------|--------------------|-----------|----|------|--------|
|  FBL74100039 | 580/330 | 72/97 | 158 | 240 | Alluminio | 20 | 7016 | 101,10 |



BRACCIO ESTENSIBILE PER PROFILO

Da utilizzare su profilo con base per piano

| ART. | L mm | P mm | H mm | angolo rotazione ° | materiale | KG | RAL | € |
|--|---------|-------|------|--------------------|-----------|----|------|--------|
|  FBL74180039 | 621/371 | 57/90 | 158 | 260 | Alluminio | 20 | 7016 | 104,10 |



PROFILO CON BASE PER PIANO

| ART. | L mm | P mm | H mm | adatto per | materiale | KG | RAL | € |
|--|------|------|------|---|-----------|----|------|-------|
|  FBL74160039 | 100 | 100 | 504 | Piano in multiplex-Piano in MDF con copertura gommata | Alluminio | 20 | 7016 | 40,20 |



PANNELLO PER VISUAL BOX

Da utilizzare con piastra porta monitor

| ART. | L mm | P mm | H mm | Dim. foro mm | Passo mm | KG | RAL | € |
|--|------|------|------|--------------|----------|----|------|-------|
|  FBL74150039 | 601 | 31 | 313 | 10x10 | 38 | 20 | 7016 | 55,50 |

vedi Visual Box pag. 405

COMPONENTI



PIASTRA PORTA MONITOR CON STANDARD VESA

Orientabile su un asse



| ART. | L mm | P mm | H mm | RAL | € |
|--------------------|------|------|------|------|-------|
| FBL74120039 | 225 | 50 | 225 | 7016 | 13,50 |



SNODO PER PIASTRA

Da utilizzare con piastra porta monitor per orientarla su due assi



| ART. | L mm | P mm | H mm | RAL | € |
|--------------------|------|------|------|------|-------|
| FBL74110039 | 91 | 67 | 51 | 7016 | 14,70 |



COPPIA SQUADRETTE A L

Da utilizzare con piastra porta monitor



| ART. | L mm | P mm | H mm | RAL | € |
|--------------------|------|------|------|------|-------|
| FBL74170039 | 38 | 36 | 32 | 7016 | 13,80 |



VASSOIO INCLINATO



| ART. | L mm | P mm | H mm | RAL | € |
|--------------------|------|------|------|------|-------|
| FBL74130039 | 425 | 308 | 135 | 7016 | 45,30 |



1. Vassoio inclinato
2. Braccio estensibile per profilo
3. Profilo con base per piano



PORTATA



RAL 7016



ALLUMINIO

COMPONENTI



PANNELLO PER PICKING BOX

Da utilizzare con piastra porta monitor

| ART. | L mm | P mm | H mm | adatto per | KG | RAL | € |
|-------------|------|------|------|----------------------------------|----|------|-------|
| FBL74140039 | 470 | 12 | 356 | Contenitore Picking Box mis. 1/2 | 20 | 7016 | 40,80 |



BARRA AGGANCIO PER CONTENITORI PICKING BOX MIS. 1/2

| ART. | L mm | P mm | H mm | finitura | € |
|-------------|------|------|------|----------|------|
| FBLIT020099 | 445 | 14 | 89 | Zincato | 4,20 |

KIT 4 CONTENITORI PICKING BOX AIR MIS. 1

| ART. | dim. ingombro | | | colore | € |
|-------------|---------------|------|------|--------|------|
| | L mm | P mm | H mm | | |
| FBLIT0600LQ | 108 | 173 | 76 | | 5,70 |
| FBLIT060039 | 108 | 173 | 76 | | 5,70 |
| FBLIT060032 | 108 | 173 | 76 | | 5,70 |
| FBLIT06001Z | 108 | 173 | 76 | | 5,70 |
| FBLIT06002Y | 108 | 173 | 76 | | 5,70 |
| FBLIT06004Q | 108 | 173 | 76 | | 5,70 |



KIT 3 CONTENITORI PICKING BOX AIR MIS. 2

| ART. | dim. ingombro | | | colore | € |
|-------------|---------------|------|------|--------|------|
| | L mm | P mm | H mm | | |
| FBLIT0610LQ | 160 | 234 | 127 | | 8,10 |
| FBLIT061039 | 160 | 234 | 127 | | 8,10 |
| FBLIT061032 | 160 | 234 | 127 | | 8,10 |
| FBLIT06101Z | 160 | 234 | 127 | | 8,10 |
| FBLIT06102Y | 160 | 234 | 127 | | 8,10 |
| FBLIT06104Q | 160 | 234 | 127 | | 8,10 |

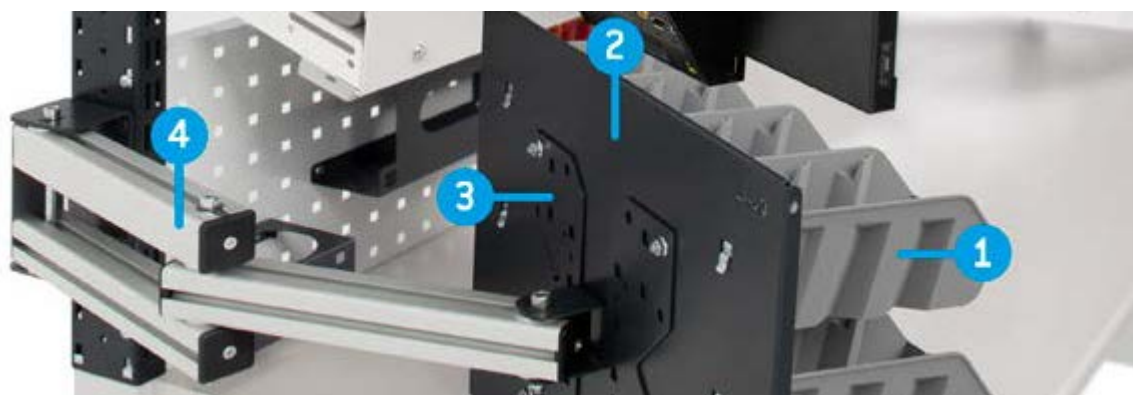

1. Barra aggancio per contenitori Picking Box mis. 1/2
Kit 4 contenitori Picking Box Air mis. 1
2. Pannello per Picking Box
3. Piastra porta monitor con standard VESA
4. Braccio estensibile per montante



CONFIGURE

SHOP

| ART. | L mm | P mm | H mm | KG | RAL | € |
|--------------|-----------|------|-----------|------|-----------|---------|
| MASTERBR1509 | 1706/3016 | 750 | 1985/2360 | 1000 | 7035+7016 | 2695,50 |

Composto da:

| qtà | descrizione | qtà | descrizione |
|-----|---|-----|---|
| 1 | Banco smontato con piano in multiplex 40 mm | 3 | Braccio estensibile per montante |
| 1 | Armadio L=560 mm con 5 cassetti 1x75 3x100 1x200 | 1 | Snodo per piastra |
| 2 | Piano superiore/inferiore L=560 mm | 2 | Piastra porta monitor con standard VESA |
| 1 | Porta totale sinistra H=600 mm con maniglia Dark Grey | 1 | Vassoio inclinato |
| 1 | Piano interno L=558 mm | 1 | Pannello per Visual Box |
| 1 | Supporto semipiano intermedio | 1 | Cassettiera Visual Box con 5 cassetti |
| 2 | Pannello forato laterale | 2 | Cassettiera Visual Box con 6 cassetti |
| 1 | Kit 2 montanti biasolati | 1 | Cestino capacità 30 L |
| 1 | Kit 2 pannelli forati/mensole con 1 bordo fermacasse | 2 | Porta bombolette inclinato a 2 posti |
| 1 | Kit 2 supporti inclinati con binario | 1 | Tasca porta documenti A4 |
| 1 | Lampada doppia | 1 | Kit porta rotolo con carta Ø=130 mm |
| 1 | Pensile vasistas senza serratura | 3 | Gancio Unipok per utensili - confezione 30 pezzi |
| 1 | Barra led | 2 | Barra aggancio per contenitori Picking Box mis. 1/2 |
| 1 | Coppia staffe di fissaggio pensile su montanti | 1 | Kit 4 contenitori Picking Box Air mis. 1 |
| 1 | Kit 3 contenitori Picking Box Air mis. 2 | | |

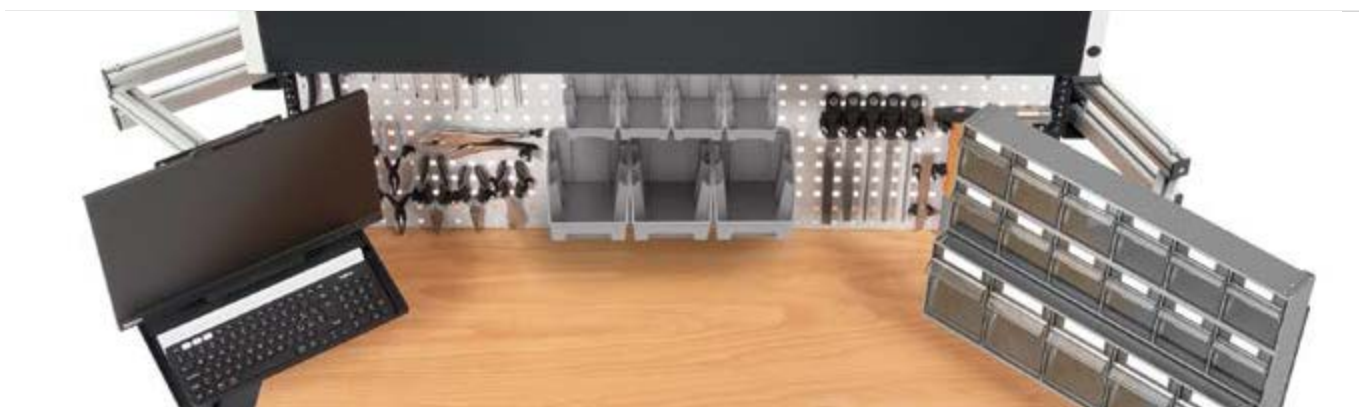

PORTATA



RAL 7035 + RAL 7016



RAL 7016





ZINCATO

COMPONENTI





PANNELLO FORATO/MENSOLA

| ART. | L mm | P mm | H mm | Dim. foro mm | Passo mm | RAL | € |
|---|------|------|------|--------------|----------|------|-------|
|  FBL76070008 | 647 | 40 | 304 | 10x10 | 38 | 7035 | 23,40 |
|  FBL76070004 | 647 | 40 | 304 | 10x10 | 38 | 5012 | 23,40 |





PANNELLO FORATO/MENSOLA CON 1 BORDO FERMACASSE

| ART. | L mm | P mm | H mm | Dim. foro mm | Passo mm | RAL | € |
|---|------|------|------|--------------|----------|------|-------|
|  FBL76080108 | 647 | 40 | 456 | 10x10 | 38 | 7035 | 37,20 |
|  FBL76080104 | 647 | 40 | 456 | 10x10 | 38 | 5012 | 37,20 |



KIT CERNIERE PER PANNELLO FORATO

| ART. | L mm | P mm | H mm |  KG | € |
|---|------|------|------|--|-------|
|  FBL7600011F | 76 | 38 | 64 | 60 | 31,50 |

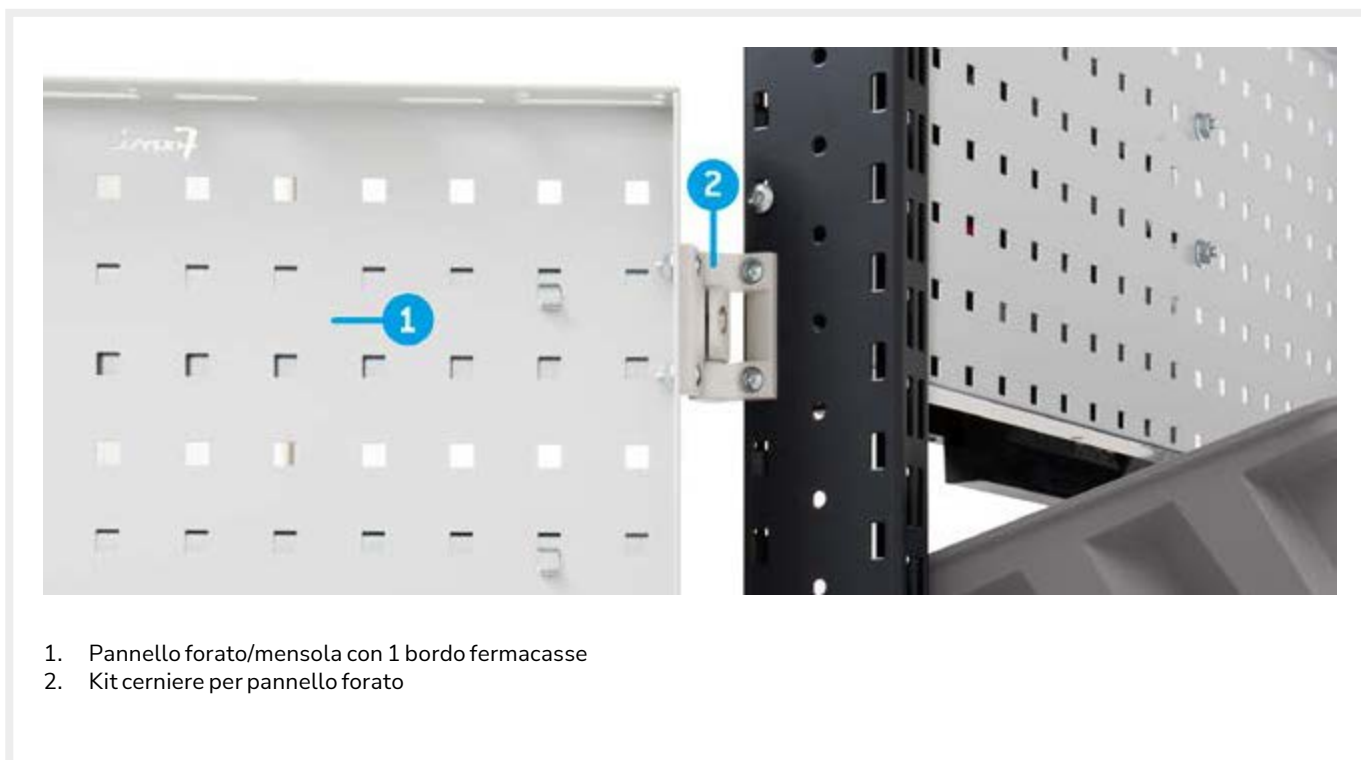

1. Pannello forato/mensola con 1 bordo fermacasse
2. Kit cerniere per pannello forato



[CONFIGURE](#)

[SHOP](#)

PATENTED*

| ART. | L mm | P mm | H mm | KG | RAL | € |
|--------------------|-----------|------|-----------|-----|-----------|---------|
| DYNAMIC1505 | 1497/1672 | 780 | 1983/2383 | 400 | 7035+7016 | 2817,30 |

Composto da:

| qtà | descrizione |
|-----|---|
| 1 | Banco smontato regolabile elettricamente |
| 1 | Armadio L=500 mm con 1 cassetto H=150 mm |
| 1 | Coperchio per armadio L=500 mm |
| 1 | Coppia supporti per armadio |
| 1 | Telaio portaprese aggiuntivo completo di tamponi e angolari |
| 1 | Kit 2 montanti biasolati |
| 1 | Coppia supporti per parete attrezzata L=1000 mm |
| 1 | Kit 2 supporti inclinati con binario |
| 1 | Lampada doppia |
| 1 | Kit 3 pannelli forati/mensole con 2 bordi fermacasse |
| 1 | Pannello forato Electric |
| 4 | Kit 2 contenitori Picking Box Air mis. 3A2 |
| 2 | Porta bombolette inclinato a 2 posti |

| qtà | descrizione |
|-----|---|
| 1 | Magnetotermico differenziale |
| 1 | Multipresa schuko a 4 scomparti |
| 2 | Multipresa schuko a 2 scomparti |
| 1 | Cavo di collegamento wieland schuko/francese |
| 1 | Coppia squadrette a L |
| 1 | Snodo per piastra |
| 1 | Piastra porta monitor con standard VESA |
| 2 | Pannello forato/mensola con 1 bordo fermacasse |
| 2 | Kit cerniere per pannello forato |
| 6 | Barra aggancio per contenitori Picking Box mis. 1/2 |
| 2 | Kit 4 contenitori Picking Box Air mis. 1 |
| 4 | Kit 3 contenitori Picking Box Air mis. 2 |



PORTATA



RAL 7035 + RAL 7016



RAL 5012



RAL 7035